

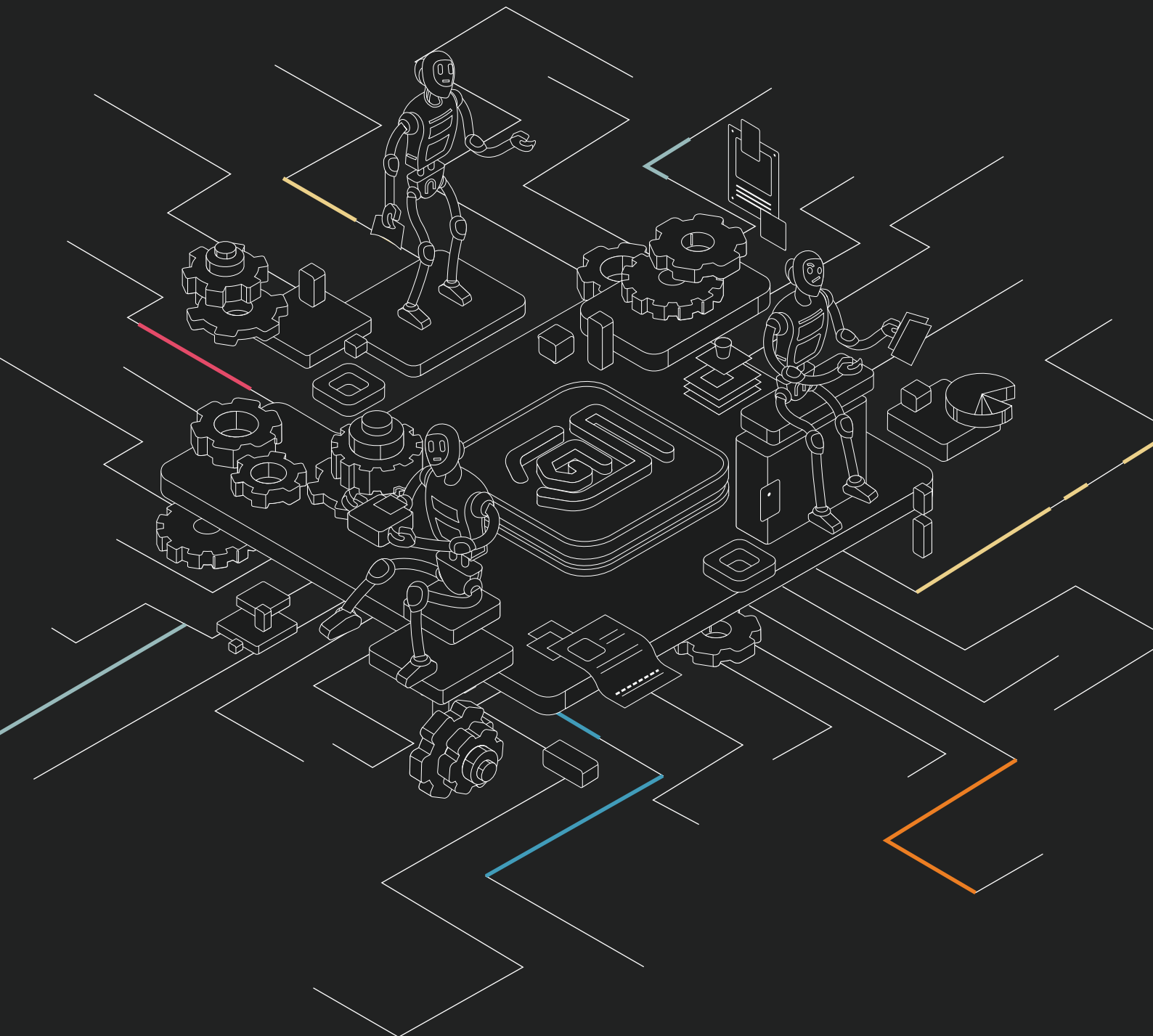

**Global Legal Solutions**

**GLS Overflow**





# GIVE YOUR LEGAL TEAM A BOOST

While the GLS group places most of its focus on innovation, sometimes our clients' most pressing need is a plug'n'play, managed legal support capacity solution. GLS Overflow does exactly that, offering access to a broad legal skill set to supplement your legal team's day-to-day needs.

Whether you need strategic leadership or just a safe pair of extra hands, GLS Overflow is immediate, scalable, and available to you at short notice at exceptional price points.

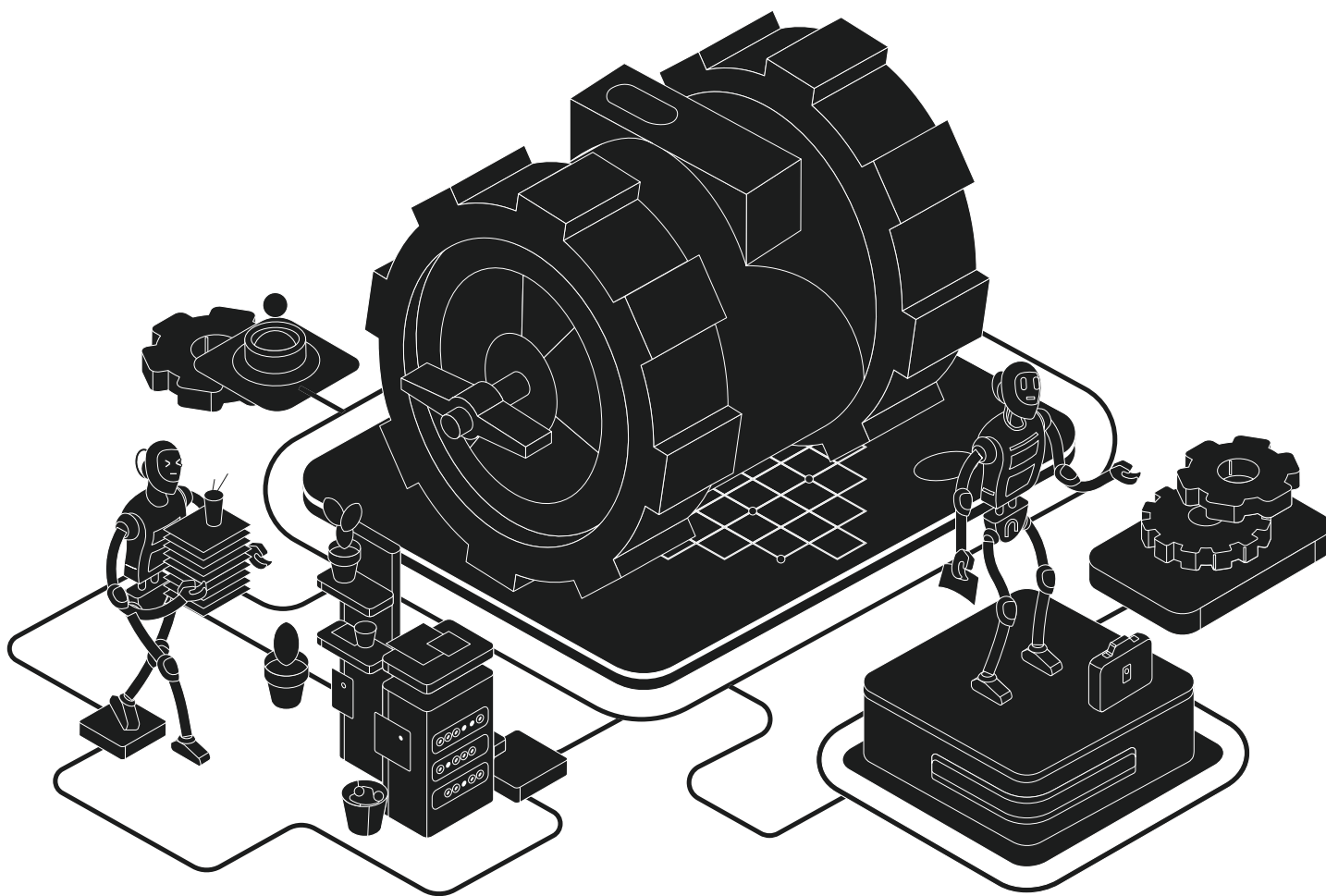

## DYNAMIC, *BY DESIGN*

By reflecting the demands of the in-house environment, GLS Overflow has become our best-selling in-house legal team capacity solution. Our lawyers have the knowledge and experience to provide commercially savvy counsel and high impact support for all scenarios. With a strong in-house focus specialising in practical, commercial law, this is a dynamic, flexible service that adapts to the needs of your team.

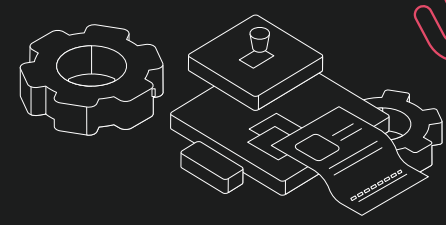

# THE STAFFING PROBLEMS WE SOLVE

There are a number of scenarios where a short term, high impact solution is the answer. While you might have your own, these are some of the routine problems we solve.

**HFS**

## HEADCOUNT FREEZE SOLUTIONS

The support you need when you cannot hire additional full/part time staff.

**SBS**

## SEASONAL BUSINESS SOLUTIONS

Helping you cover the ebbs and flows of the annual business cycle.

**ACS**

## ABSENCE COVERAGE SOLUTIONS

Holiday, sickness, sabbatical and maternity/paternity leave scenarios.

**BCS**

## BURST CAPACITY SOLUTIONS

When you need to get many hours of work done quickly to meet deadlines beyond what your team can achieve.

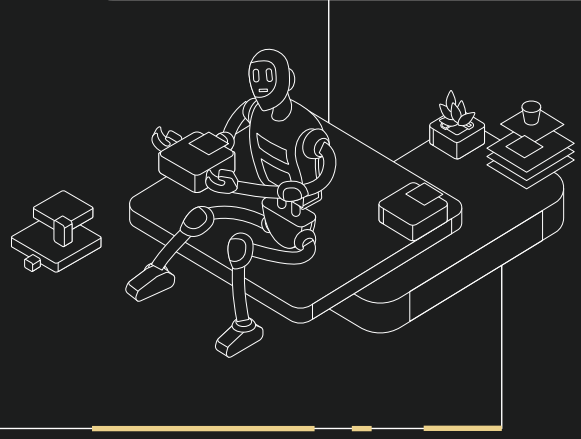

**ES**

## EXPERTISE SOLUTIONS

When you need to access expertise that your team does not currently have due to an exceptional support requirement.

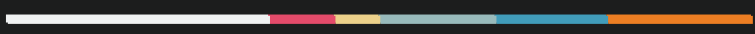



## BUDGET ISSUES

Support at a similar cost to an in-house lawyer, with far better resources than a law firm, delivering far greater productivity.



## UPSKILL

Upskilling your in-house teams in new areas by having them work alongside our senior resources.



## HIRING CHALLENGES

Get you the support you need as you work through your full-time hiring process.

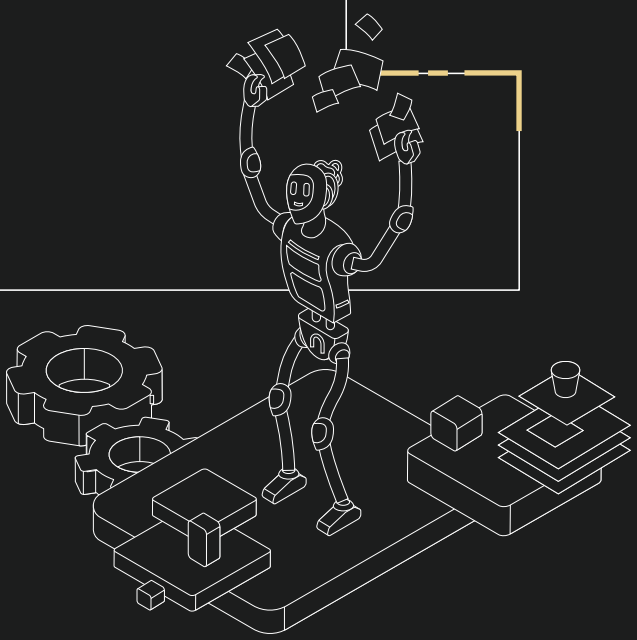

## SPECIAL PROJECTS

Skills to cover restructurings, regulatory investigations, major litigation, acquisitions, new market entries, etc.

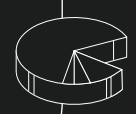

## ACCESSING SENIORITY

When you need to access Head of Legal / Partner level expertise.

Given the “managed” nature of the GLS Overflow solution, it has also rapidly become a permanent resourcing feature for a growing number of our client legal teams.



## HOW DOES IT *WORK?*

Simply click [here](#) and review the specific benefits of each GLS Overflow support package. Then select a capacity plan that suits you. Exceptional price points are achieved by pre-purchasing blocks of capacity that give you 24/7 access to a diverse in-house support resource.

For Silver plans and above, we will assign a Relationship Manager (RM) and diagnose your group legal positions to ensure calibrated support. This allows us to provide a truly “managed” capacity solution including reporting transparency and pro-active efficiency recommendations.

To take advantage of your flexible hourly packages, you can submit a support request to us at any time. Once you are signed in, use our pro-forma guide quality instructions, submit your instruction, and you’re good to go.

If you’ve overcommitted, don’t worry. Any balance on your account can be used at our [Legal Operations Centre](#) (LOC) to tap into 800+ legal products and tools created to enhance your team’s performance.

## THE BETTER *SOLUTION*

No legal team has all the resources it needs all the time, because those needs are always changing and no team has infinite resources. We work to enhance the long-term efficiency of your team by giving you access to the lawyers you need, when you need them, along with additional support resources for most capacity tiers.

For too long now the workload of in-house legal teams has grown unnecessarily large because it simply takes far too long to engage traditional support resources – or because the assignment was considered too small to brief out externally. GLS Overflow provides instant support for any project, no matter the size nor the deadline, and delivered by a team that increasingly knows exactly how you like to work.

Think of GLS Overflow as the entire reserve bench of a world beating sports team. These super-subs are high impact individuals with particular skills that can be called upon to have game-changing impact under specific circumstances.

Collectively, our lawyer pool covers far more industries, practice areas and years of experience than any one lawyer you can hire. And they will be supported by the entire resource pool of the GLS Group. They are dynamic, resourceful and ready to help elevate your team.





## INNOVATE, *DON'T PROCRASTINATE*

A successful in-house legal team needs both continuity and innovation. So let your in-house team remain stable, whilst GLS Overflow contributes new efficiency solutions and incredible features:

- **Client Preference Manual:** to continuously capture and reflect your working preferences
- **Reporting:** near real time tracking of matter progress and weekly reporting on select plans
- **Training Inclusions:** qualifying plans can access free legal team training modules
- **LOC Credits:** qualifying plans attract additional credit on the [Legal Operations Centre](#)
- **Rapid Mobilisation:** instantly mobilised, readily available
- **Technology Enabled:** unrivaled practitioner legal technology support
- **Performance Focused:** regular monthly RM workflow performance reviews
- **Efficiency Strategy:** regular workflow, strategy and policy efficiency recommendations
- **Time Task Compression:** 30%+ time reduction for many routine legal tasks
- **Additional LOC Discounts:** a 5% discount on paid products for qualifying plans
- **Volume Discounts:** use your purchasing power to access further pricing efficiencies

## UNBELIEVABLY AFFORDABLE – *AND SO MUCH MORE*

Firstly, our rates are exceptional and prove that from the right legal service provider platform – accessing world class talent can be substantially more affordable than traditional market providers.

Any doubts? Well, traditional law firms are charging over US\$400ph for newly qualified lawyers and paying them more than \$200,000 per year. They would go broke charging you at our rates!

But GLS is not a law firm (unless you need us to be) – we are an in-house legal team *and* dedicated solutions provider. So, we offer far more than just lawyers – which means you can access lawyers through an unbelievable price and value proposition.

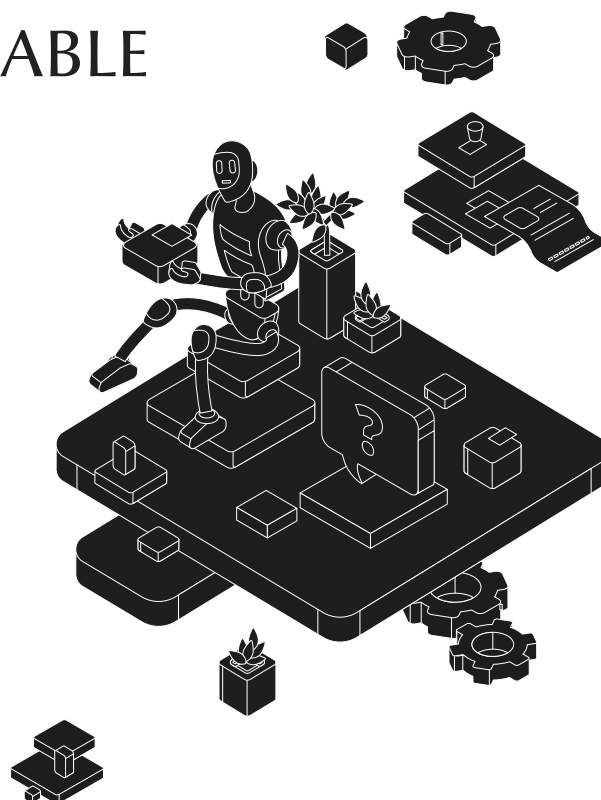



Take a look at our capacity plans below to see not only great rates, but additional value:

GLS OVERFLOW	FEES (EXCL. VAT)	STANDARD OVERFLOW RATE (P/H)	RM MANAGED	TRAINING INCLUSIONS	LOC CREDIT
1000hrs	US\$199,000	US\$199	Y	5 sessions	US\$15,000
400hrs	US\$91,600	US\$229	Y	2 sessions	US\$4,500
100hrs	US\$24,900	US\$249	Y	1 session	US\$650
50hrs	US\$13,450	US\$269	Y	N	N
10hrs	US\$2,990	US\$299	N	N	N

**GLS Relationship Manager:** our dedicated RM will assess your workflows and identify potential working practice efficiencies, provide reporting transparency and help you use your resources.

**Team Training On Us:** we will help you with your legal team training burden. Depending on your capacity tier – you will be free to access any of the world class training modules available on the Legal Operations Centre.

**Legal Operations Centre Credit:** for qualifying tiers, we give you additional credit to purchase digital solutions from the LOC – e.g. templates, policies, checklists, training etc. You can, on us, experience the exponential productivity outcomes of great lawyers with great in-house tools.

So, what’s there not to like? At a price point the same (or even better) than the fully loaded cost of your own team members by reference to actual productivity hours – GLS Overflow delivers the support you need, when you need it.

## GET *IN TOUCH*

The GLS Group is proud to create optimally efficient, affordable legal services that benefit the world. We would love to help your business.

Please feel free to get in touch [here](#).



[www.gls-legaloperations.com](http://www.gls-legaloperations.com)

The material in this document is subject to copyright © owned by GLS Solutions Pte Ltd Any unauthorised use, duplication, circulation, or redistribution of any part of this document in any media is strictly prohibited  
GLS Solutions Pte Ltd (Reg. No. 201415106W), 37 Beach Road #02-01, Singapore 189678 | T: +65 6817 8204 | E: [info@glsglobal.com](mailto:info@glsglobal.com) | W: [www.gls.global](http://www.gls.global)